



Bean.

Been there.
Never done that.

Why hide my seams?
The grooves in my face bring out my personality: angular and playful.
I am Bean. Feel free to experiment with my laying direction.
My weave pattern playfully shifts in the changing light.
My motif turns and tilts, I'm here, there, I'm everywhere.

Bean.

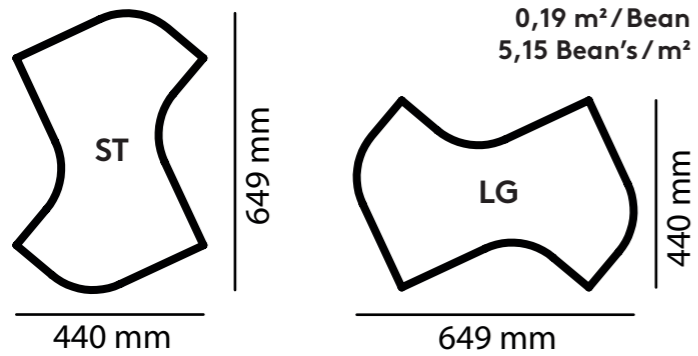

inspiration.

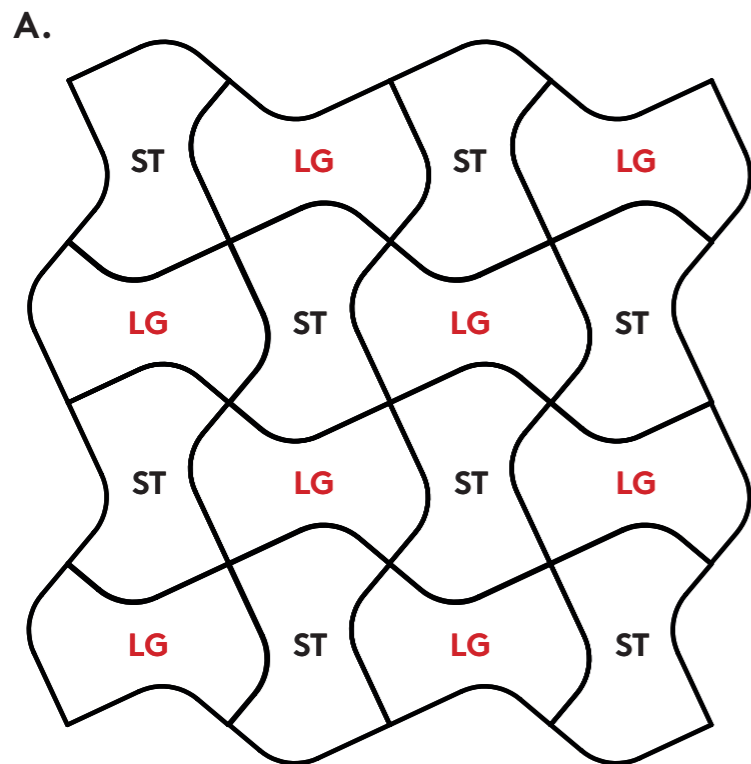

- color combination: 2 or more
* the use of only 1 color is not possible here because you would not see any difference in color.

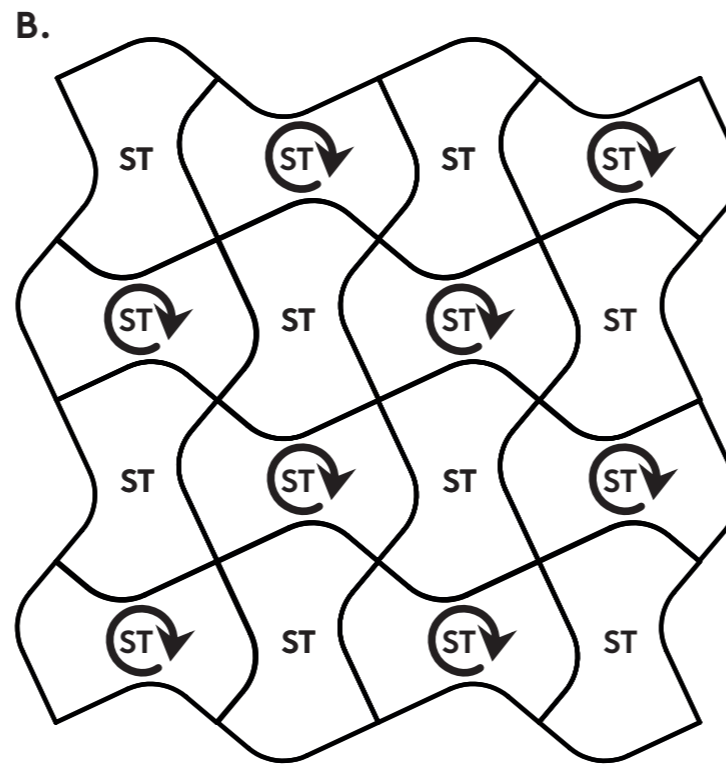

- color combination: 1 color or more

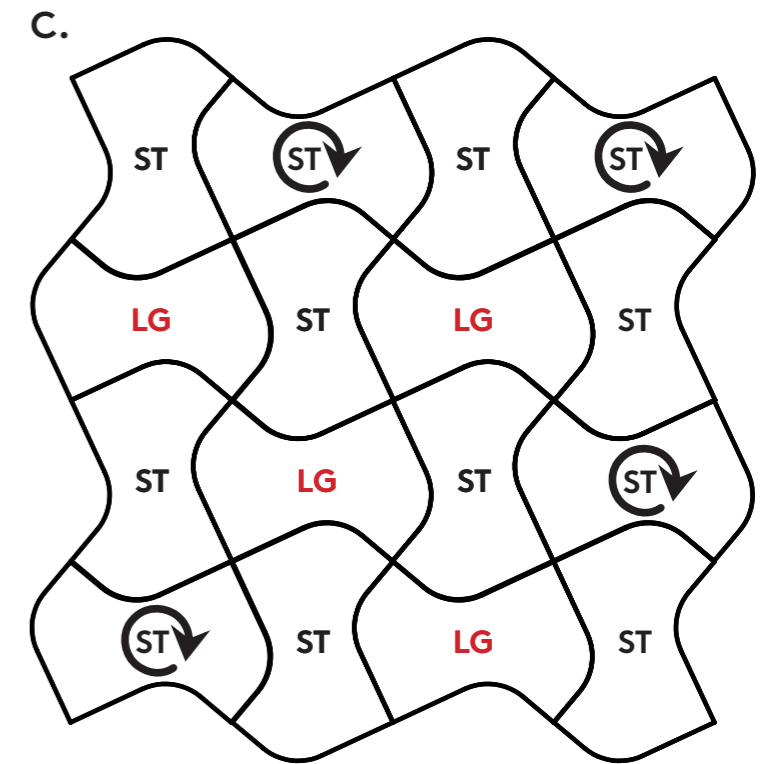

- color combination: 1 color or more

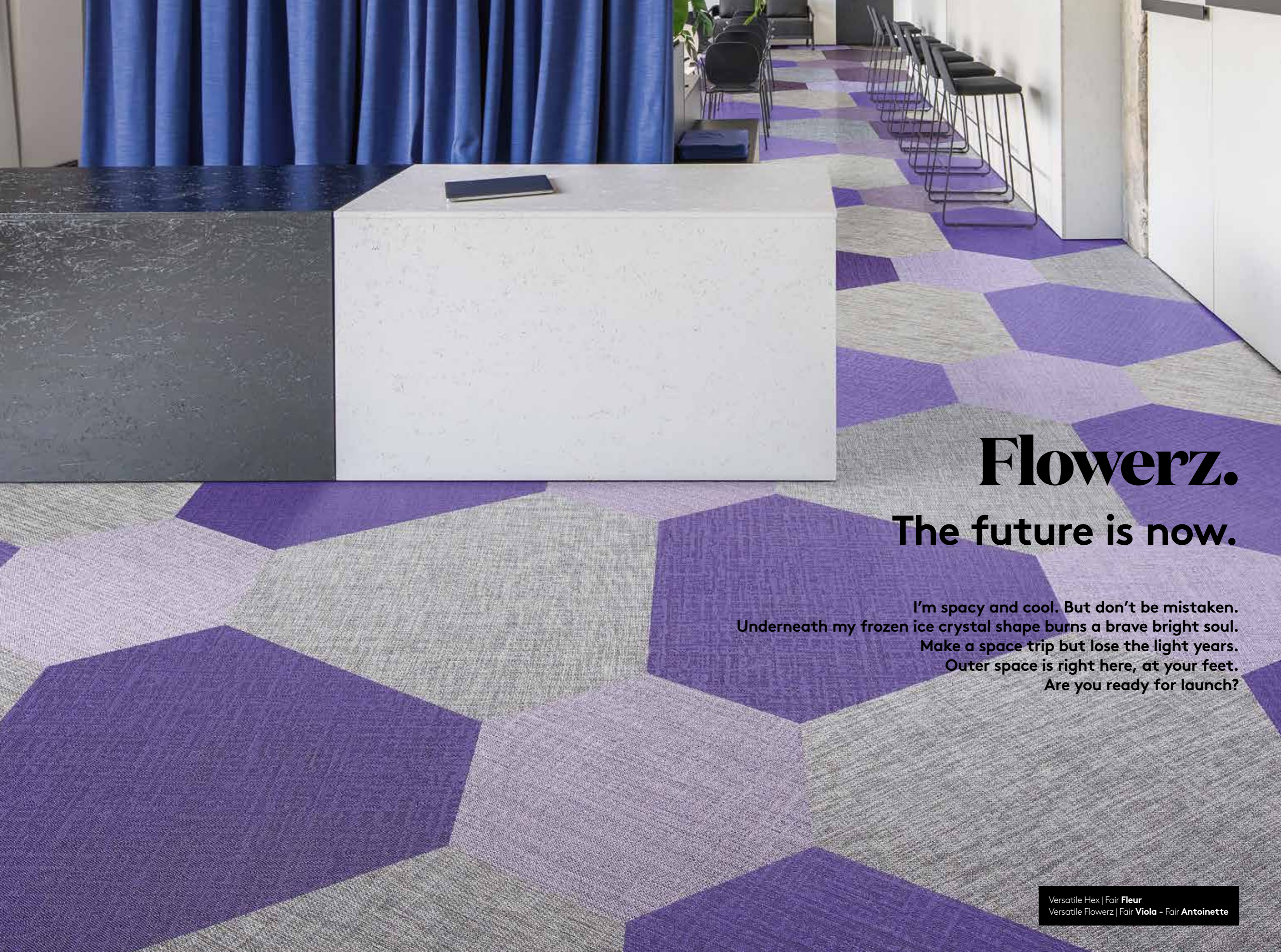

Flowerz.

The future is now.

I'm spacy and cool. But don't be mistaken.
Underneath my frozen ice crystal shape burns a brave bright soul.
Make a space trip but lose the light years.
Outer space is right here, at your feet.
Are you ready for launch?

Flowerz.

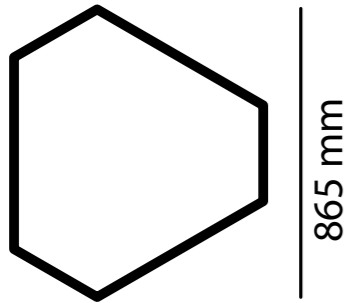

0,47 m² / Flowerz
2,14 Flowerz's / m²



inspiration.

A.

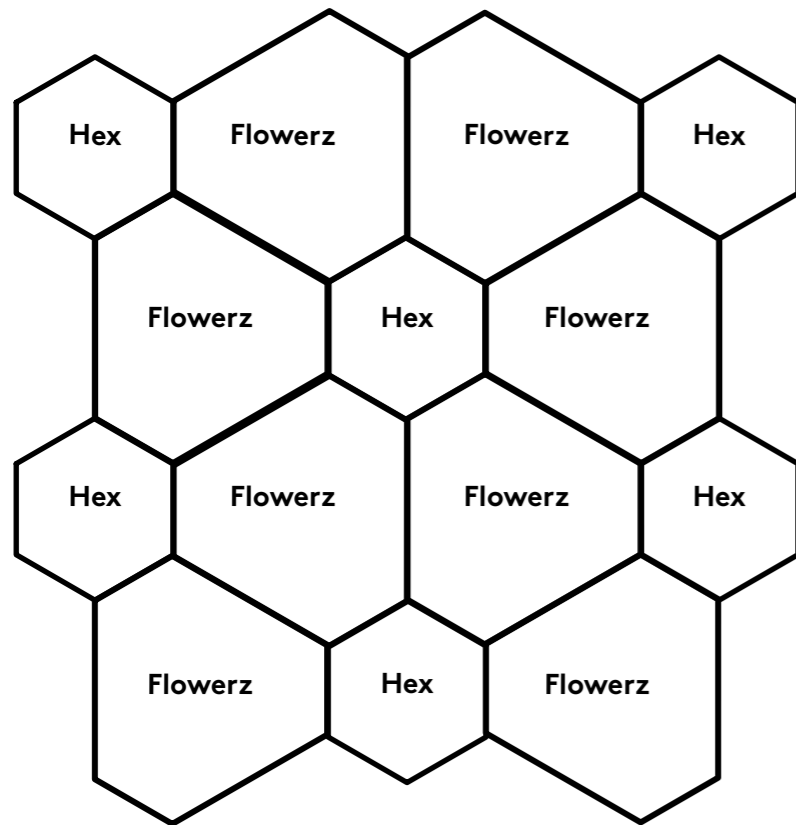

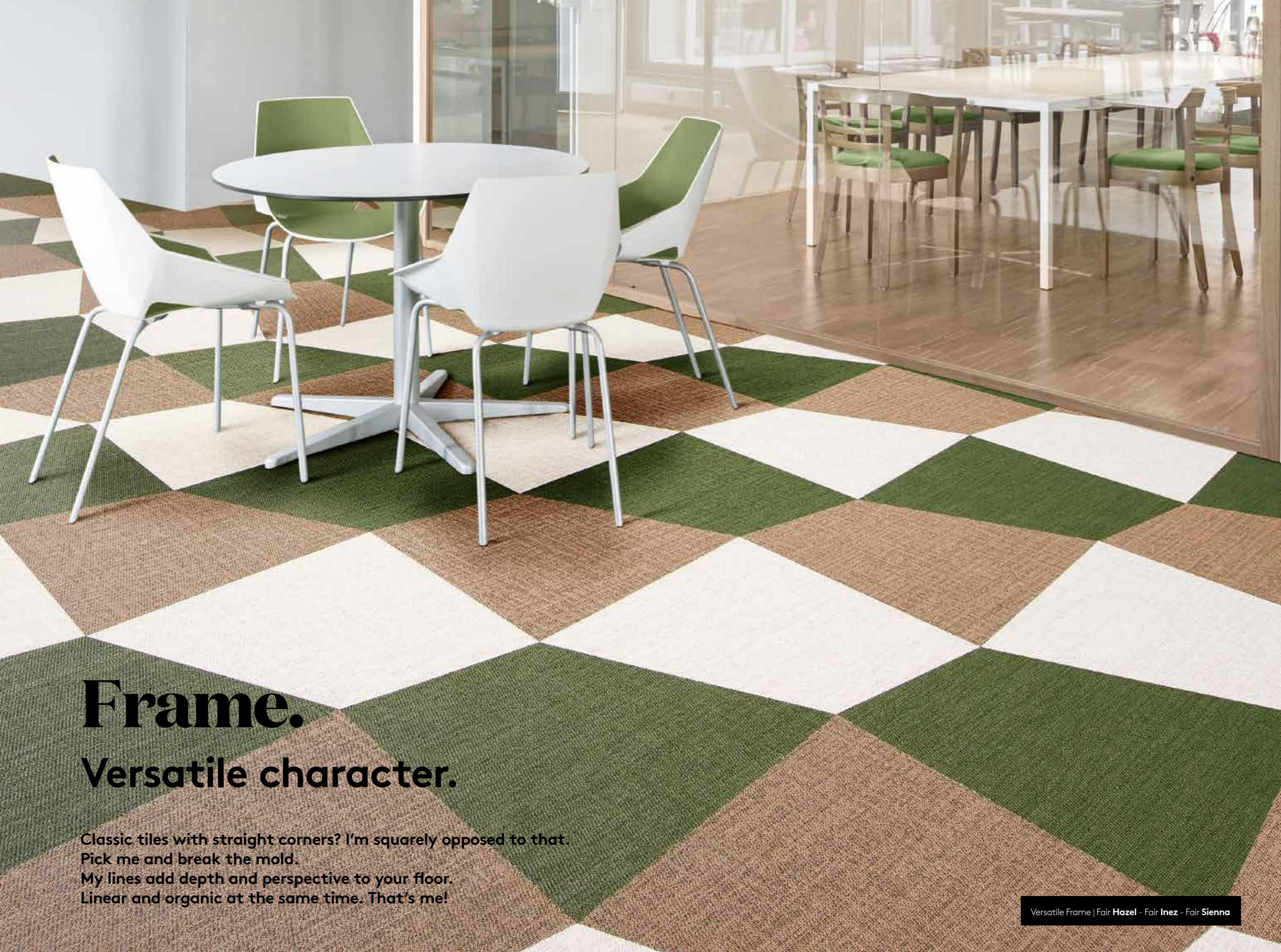

Frame.

Versatile character.

Classic tiles with straight corners? I'm squarely opposed to that.
Pick me and break the mold.
My lines add depth and perspective to your floor.
Linear and organic at the same time. That's me!

Frame.

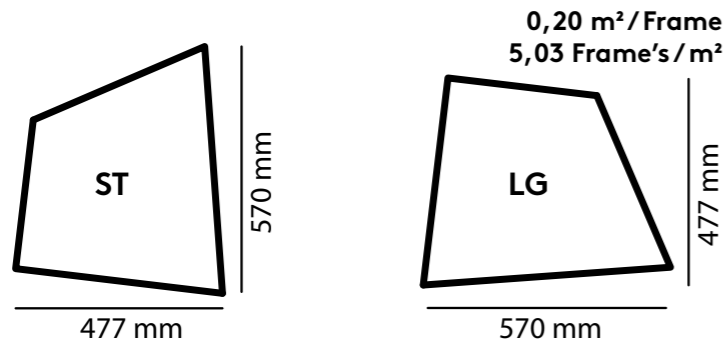

inspiration.

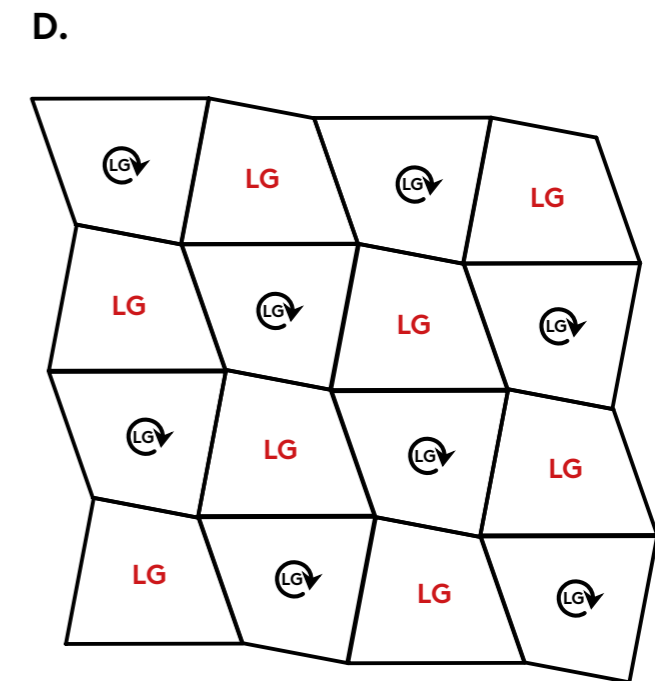
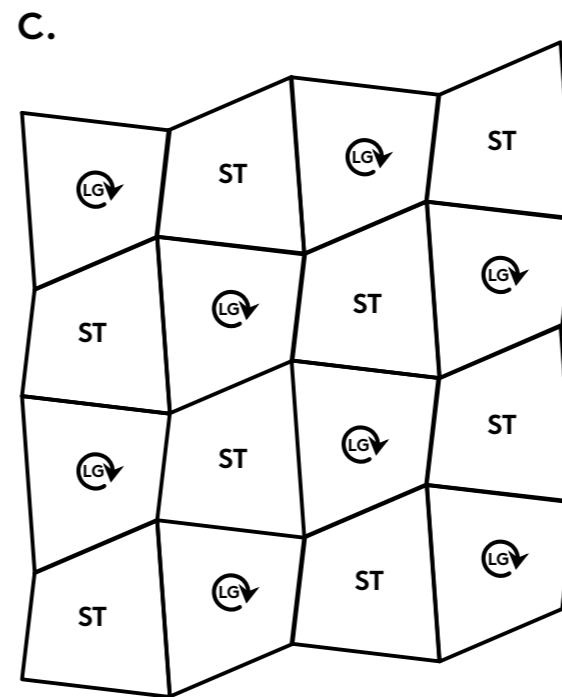
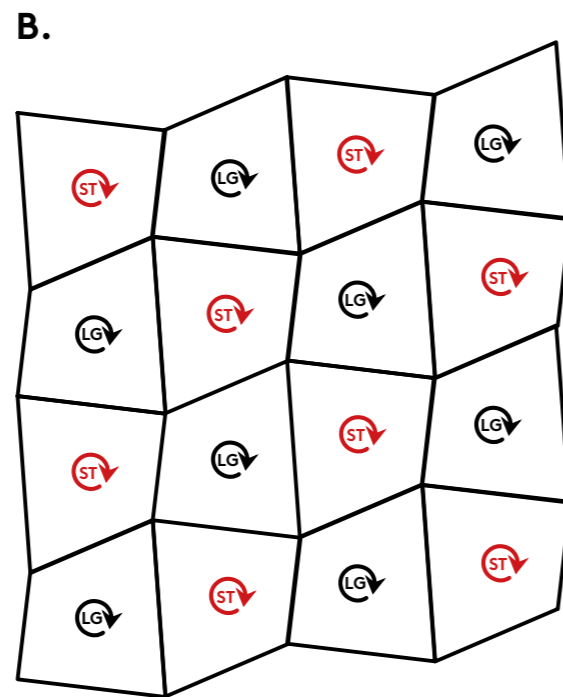
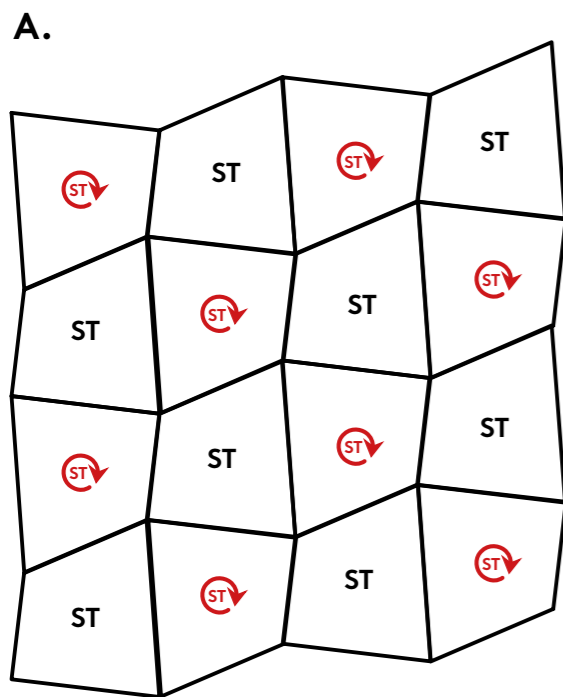

- color combination: 2 or more
* the use of only 1 color is not possible here because you would not see any difference in color.

- color combination: 1 color or more

- color combination: 2 or more
* the use of only 1 color is not possible here because you would not see any difference in color.

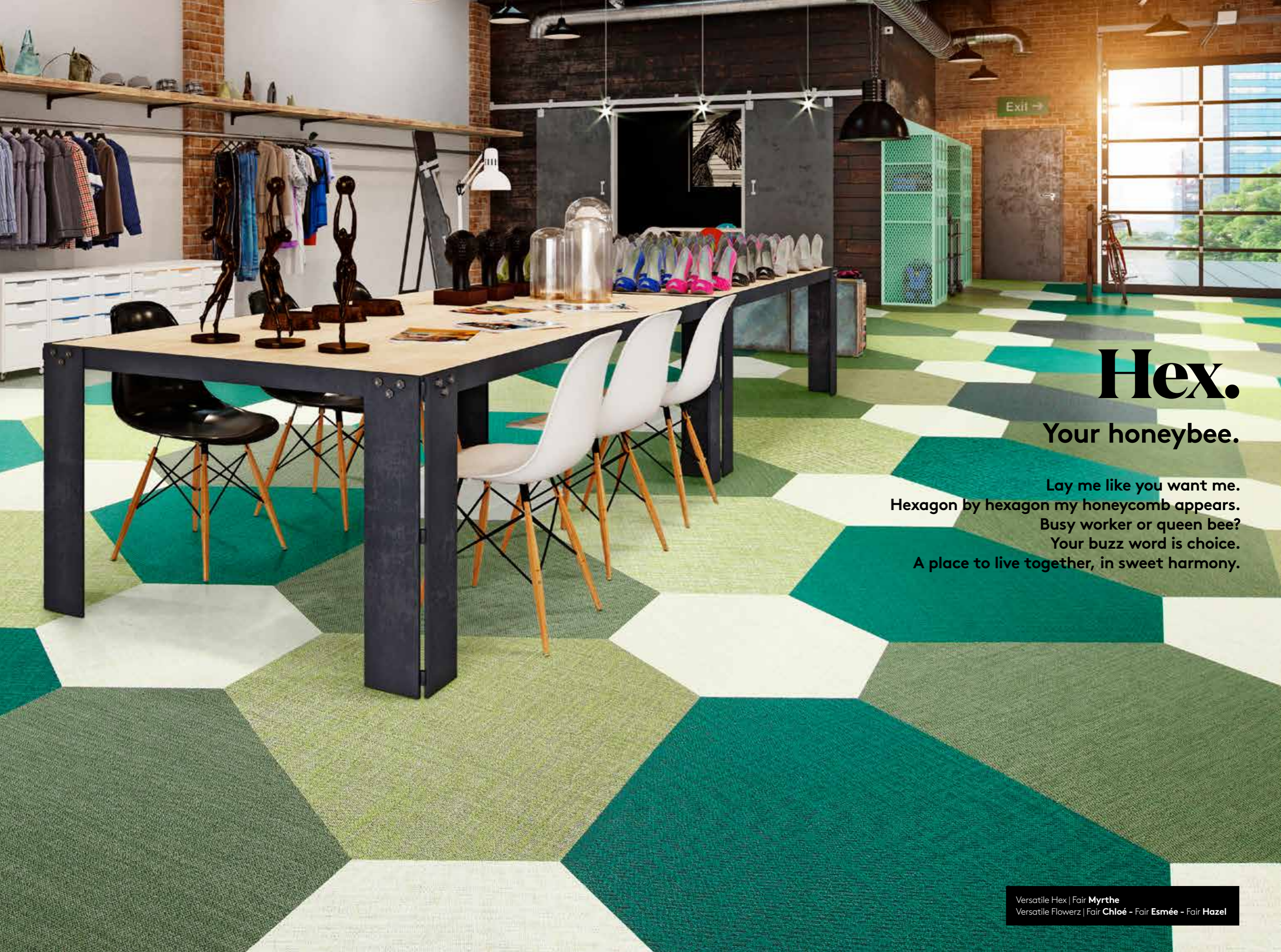

Hex.

Your honeybee.

Lay me like you want me.
Hexagon by hexagon my honeycomb appears.
Busy worker or queen bee?
Your buzz word is choice.
A place to live together, in sweet harmony.

Hex.

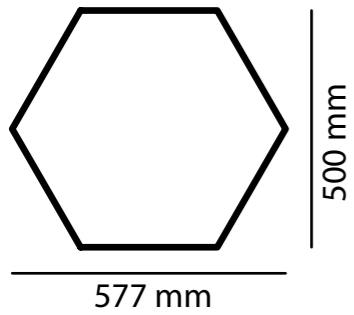

0,22 m² / Hex
4,63 Hex's / m²



inspiration.

A.

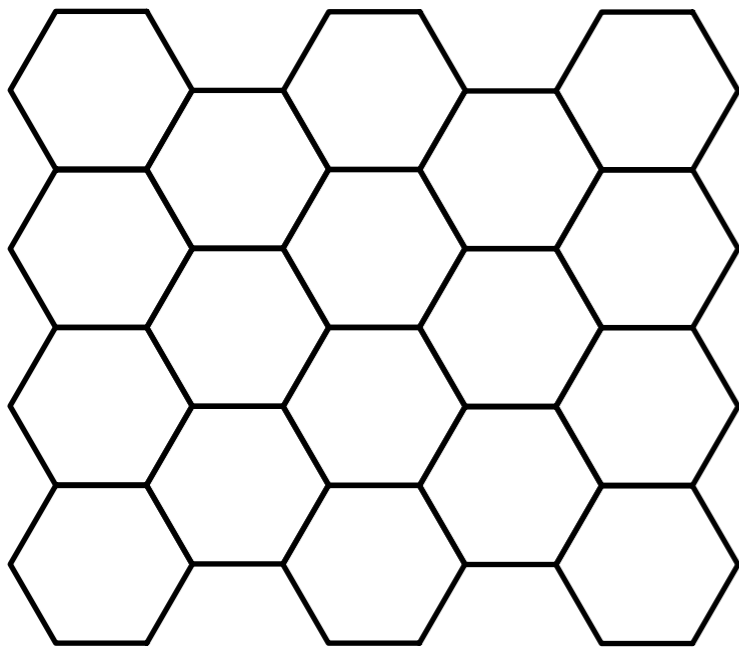

- color combination: 1 color or more

B.

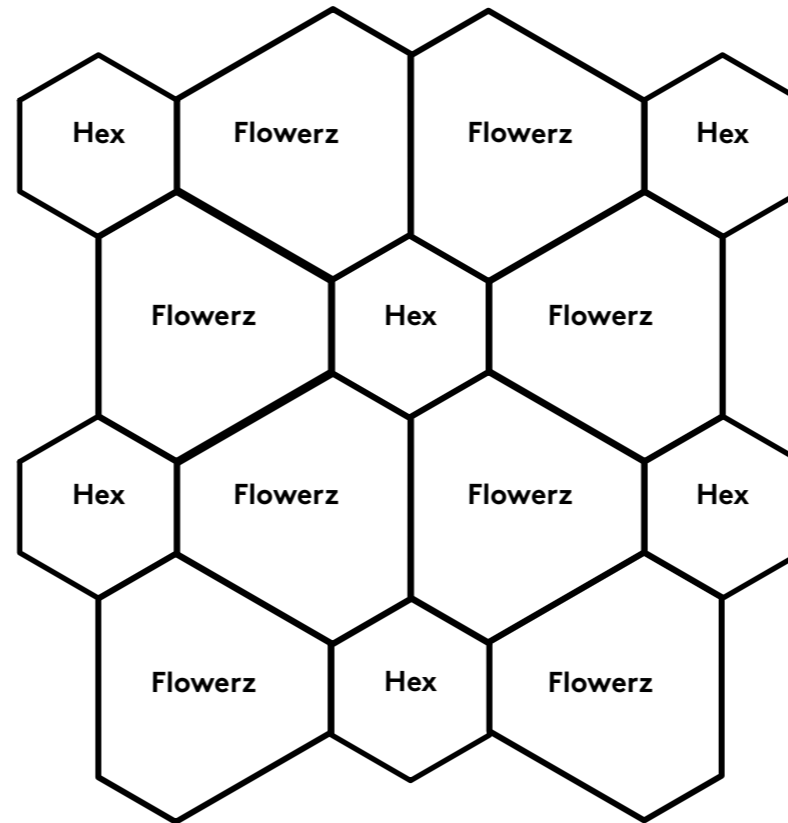



Plank.

In line with your style.

**30x100. That is my basic shape. Clean and tight.
But don't be mistaken. This vinyl plank floor opens up 30x100 possibilities.
Just lay me like you want me:
crisscross like dominoes or in a linear piano pattern.
And how about herringbone or zebra crossing?**

Plank.

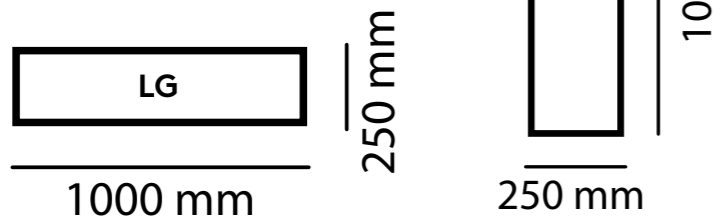

0,25 m²/Plank
4 Plank's/m²

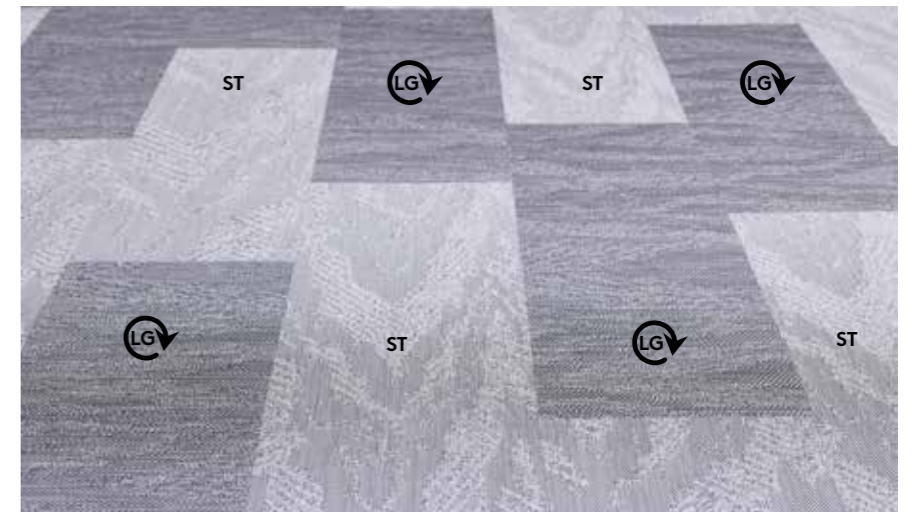
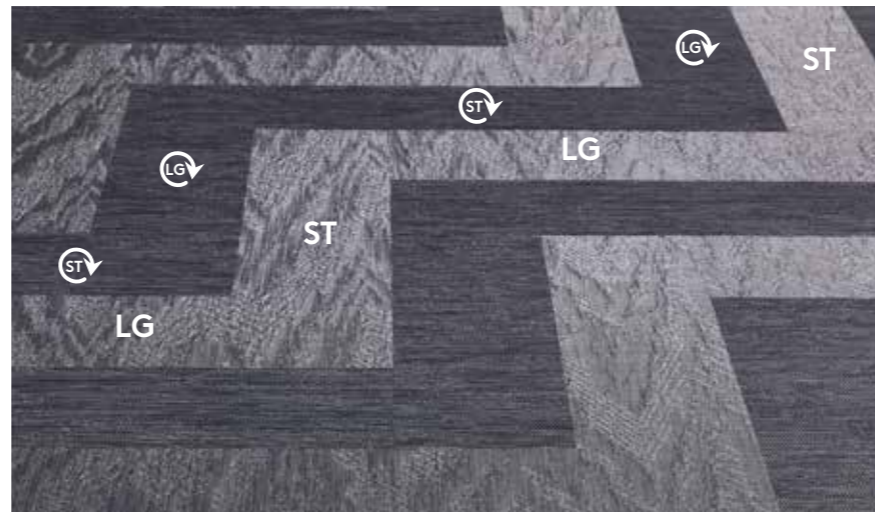

inspiration.

A.

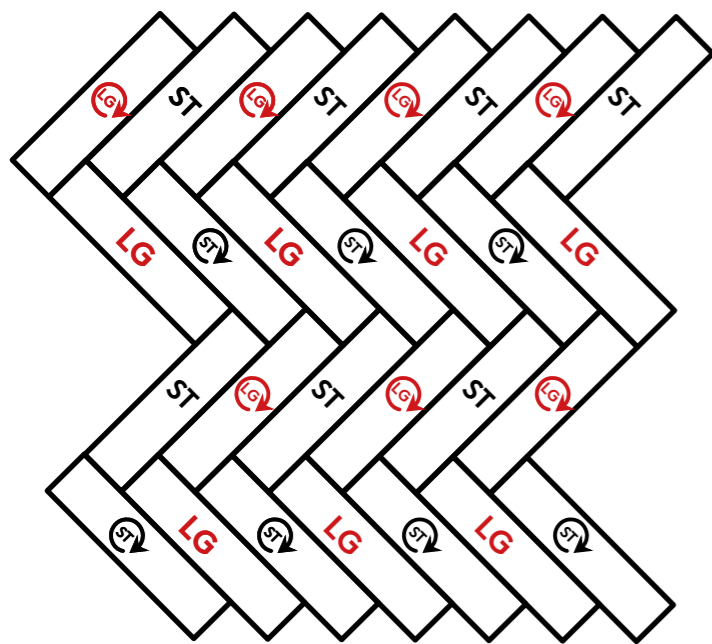

B.

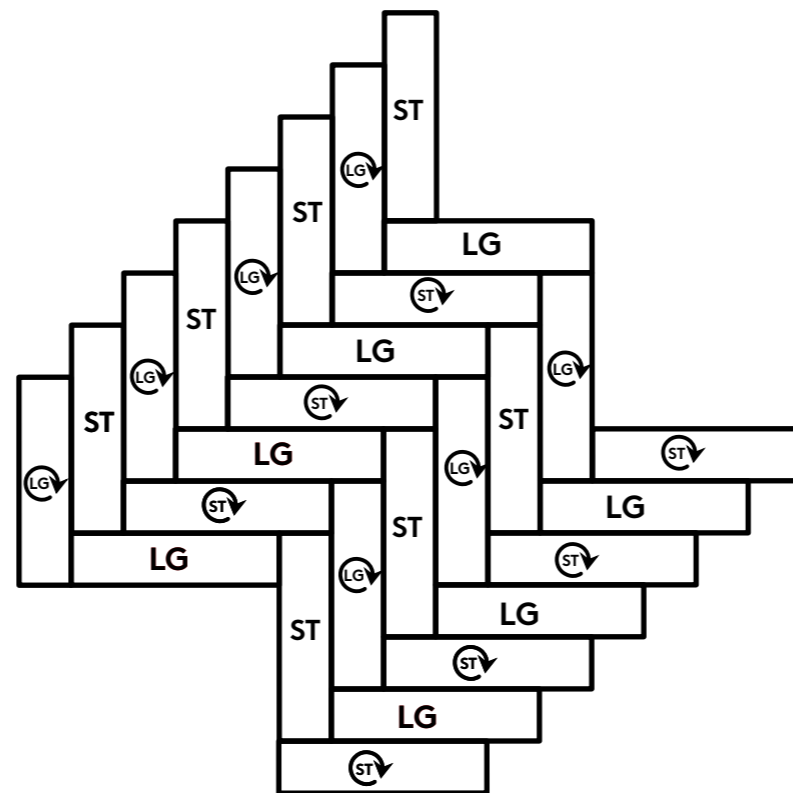

C.

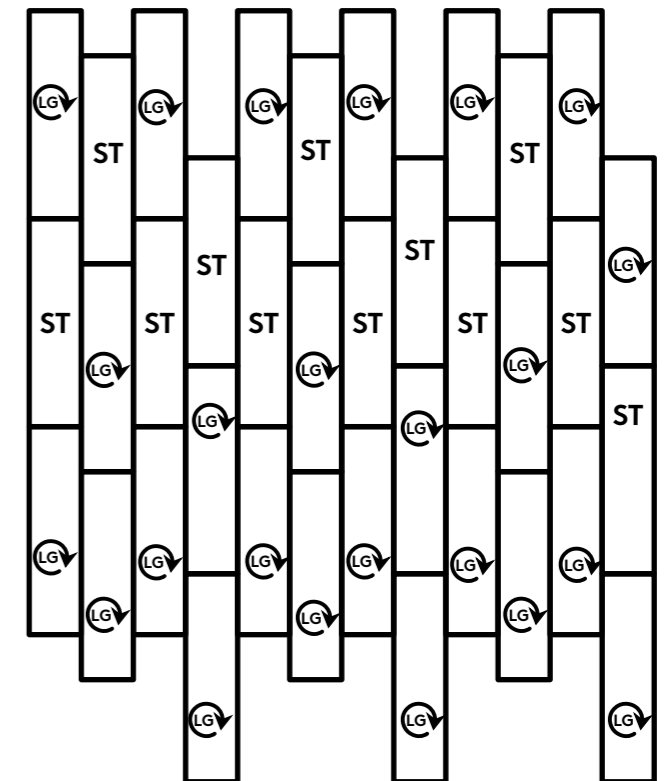

- color combination: 1 or more
* If only 1 color is used, you have to order both ST & LG to create an effect.



Star.

A star-studded power floor.

**You are face to face with a Japanese warrior.
Like razors, his throwing stars sail through your room.**

Startled starlings weave and turn.

Land on the floor, one by one.

My pattern oozes power and dynamism. Can you handle me?

Star.

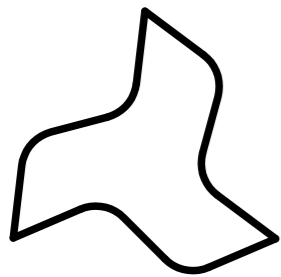

538 mm

0,13 m²/Star
8 Star's/m²

inspiration.

A.

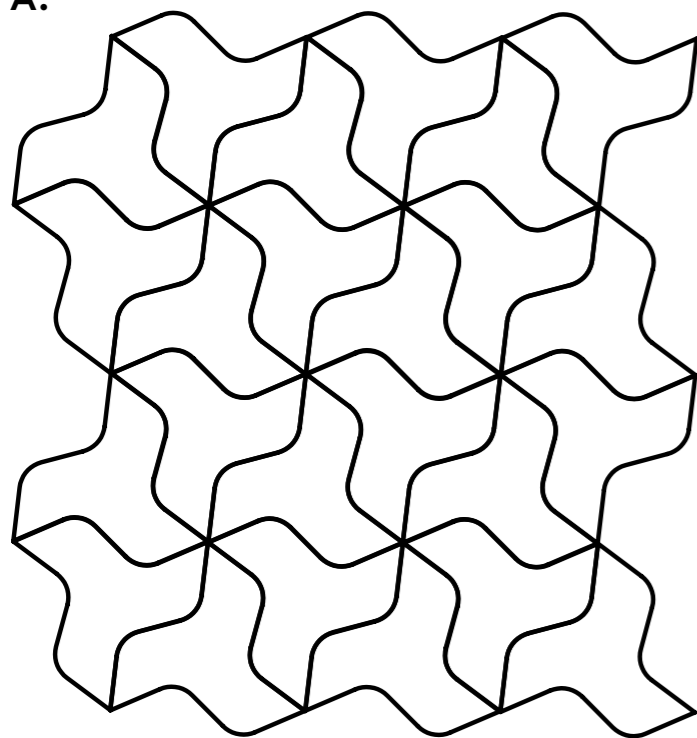

- color combination: 1 or more
* if only 1 color is used, the 'star' motif will only be slightly visible.

